

migan MPB ModbusRTU

Large Display Numeric LED with Modbus RTU Interface

User Manual



migan MPB ModbusRTU

Large Display Numeric LED with Modbus RTU Interface

Index

1	GENERAL	3
2	SYSTEM OVERVIEW	3
3	TECHNICAL INFORMATION	4
3.1	Overall Specification	4
3.2	Device Configuration	5
3.3	Pin Assignments and Settings	6
3.4	Device Start-Up	9
4	MODBUSRTU INTERFACE	10
4.1	Control Frame	12
4.2	Response Frame	14
4.3	Controlling Example	15
5	APPENDIX	16
5.1	Displayable Characters	16
5.2	Maintenance and Care	17
5.3	Declaration of Conformity	18
5.4	Warranty / Liability	19
5.5	Versions Overview	20

migan MPB ModbusRTU

Large Display Numeric LED with Modbus RTU Interface

1 General

This 7 segment displays are designed for professional use. Depending on the type of device they are suitable for indoor or outdoor use.

The modular design allows for cost-effective models of various interfaces with different character heights and numbers of digits.

2 System Overview

The display is controlled with a ModbusRTU interface.

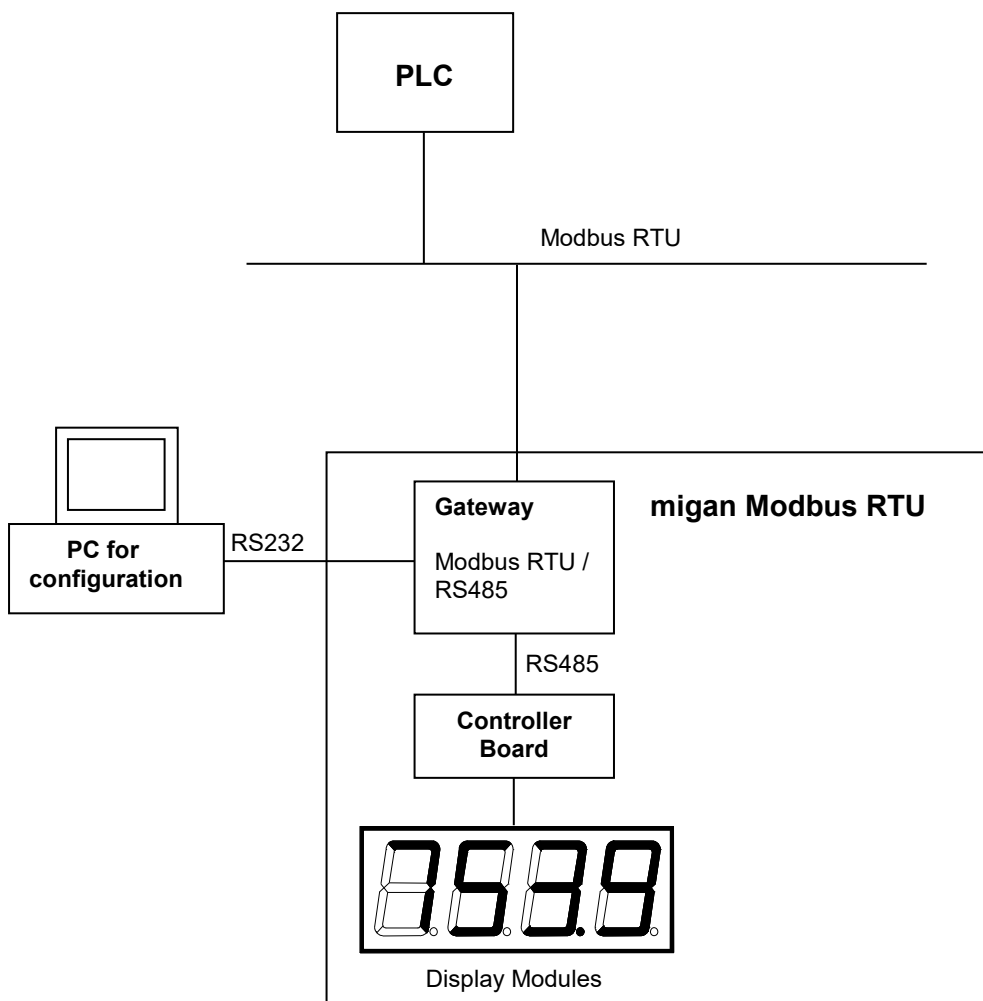

migan MPB ModbusRTU

Large Display Numeric LED with Modbus RTU Interface

3 Technical Information

3.1 Overall Specification

Display type:	7 segment SMD LED
Character heights:	indoor use: 60 / 100 / 150 / 200 / 250 mm outdoor use: 100 / 200 / 300 mm
Number of digits:	up to 100 digits
Number of lines:	standard 1 line, multiple lines on request
Display colour:	red
Operating voltage:	230 VAC / 50 Hz, 110 VAC / 60 Hz or 24 VDC $\pm 20\%$
View:	single to four-sided
Interface:	ModbusRTU
Displayable characters:	see corresponding chapter
Labelling:	upon request
Housing:	industrial version, powder coated aluminum
Housing colour:	RAL 7016 (anthracite)
Mounting:	articulated arm, angle bracket, hanging on chain or mounting frame
Protection:	see chapter "Device Configuration"
Operating temp.:	see chapter "Device Configuration"
Storage temp.:	-25 to +70 °C

migan MPB ModbusRTU

Large Display Numeric LED with Modbus RTU Interface

3.2 Device Configuration

Itemnumber : _____

Type:

for inside use for outside use

Character height:

60 mm 100 mm 150 mm 200 mm 250 mm 300 mm

Number of lines: _____ **Number of digits per line:** _____

View:

single sided double sided _____ sided

Operating voltage:

230 VAC / 50 Hz 110 VAC / 60 Hz 24 VDC

Protection:

IP40 IP54 IP65 IP _____

Operating temperature:

with type for inside use:	with type for outside use:	special version:
<input type="checkbox"/> 0...+50 °C (standard)	<input type="checkbox"/> -20...+50 °C (standard)	<input type="checkbox"/> _____ °C
	<input type="checkbox"/> -25...+50 °C (optional with heating)	

Housing dimensions: _____ x _____ x _____ mm

Housing Material:

Aluminum profile Stainless steel Sheet metal

Device address: _____

migan MPB ModbusRTU

Large Display Numeric LED with Modbus RTU Interface

3.3 Pin Assignments and Settings

9pol. Sub-D Female Connector “ModbusRTU”

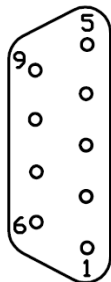

Pin	Assignment
1	
2	RS-232 TxD
3	RS-232 RxD
4	
5	GND Bus
6	+5V Bus Out
7	RS-485 D0 (Rx/Tx-)
8	RS-485 D1 (Rx/Tx+)
9	

Remark: Depending on DIP5 of the ModbusRTU-interface (see below) **either** the RS232-pins **or** the RS485-pins may be used. The unused pins have to be left open. Do **not** use a standard RS232-cable where **all** pins are connected. Otherwise the ModbusRTU-interface may be destroyed!!!

9pol. Sub-D Male Connector “Configuration, RS232”

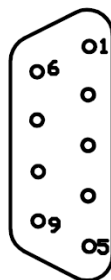

Pin	Assignment
1	
2	RxD
3	TxD
4	
5	GND
6	
7	
8	
9	

Remark: This connector should not be used by the customer! The configuration is already done by microSYST and must not be changed! Otherwise the correct function of the display can not be guaranteed!

7pol. Mains Plug (230 VAC)

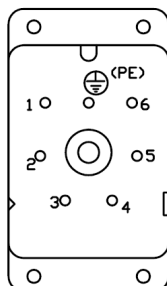

Pin	Assignm.
1	L1
2	N
3	(PE) PE
4	
5	
6	
7	

or

3pol. Circular Plug (24 VDC)

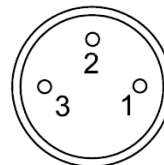

Pin	Assignment
1	GND
2	+24 VDC
3	PE

migan MPB ModbusRTU

Large Display Numeric LED with Modbus RTU Interface

Internal LEDs

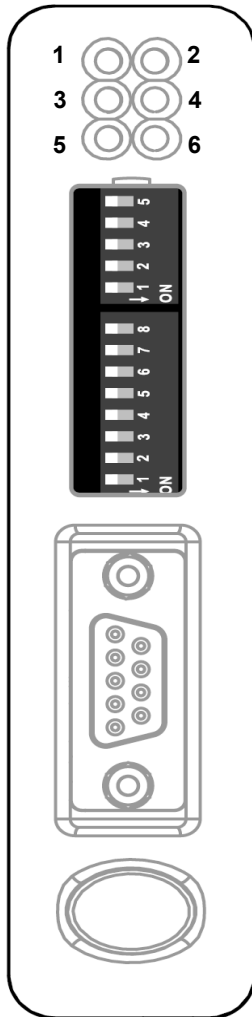

LED	State	Description
1 - Bus Error	Off	Normal operation
	Red	Bus error; CRC mismatch >10%
2 - Bus Ready	Off	Not powered
	Green	Normal operation (bus ready)
	Red	Bus is off line (bus not ready)
3 - Processing	Off	Currently not processing query
	Green, flashing	Currently processing query
4 - HW Settings	Off	Normal operation
	Red	Not configured
5 - Subnet Status	Off	Power off
	Green, flashing	Initializing and not running
	Green	Running
	Red	Stopped or subnet error, or timeout
6 - Device Status	Off	Power off
	Alternating Red/Green	Invalid or missing configuration
	Green	Initializing
	Green, flashing	Configuration OK

migan MPB ModbusRTU

Large Display Numeric LED with Modbus RTU Interface

Internal Switches

Factory settings are marked with grey colour.

ModbusRTU Node Address

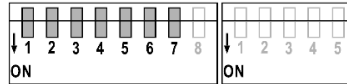

Node Address	DIP1	DIP2	DIP3	DIP4	DIP5	DIP6	DIP7
(reserved)	OFF	OFF	OFF	OFF	OFF	OFF	OFF
1	OFF	OFF	OFF	OFF	OFF	OFF	ON
2	OFF	OFF	OFF	OFF	OFF	ON	OFF
...
126	ON	ON	ON	ON	ON	ON	OFF
127	ON	ON	ON	ON	ON	ON	ON

ModbusRTU Baudrate

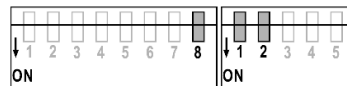

Baudrate	DIP8	DIP1	DIP2
(reserved)	OFF	OFF	OFF
1200 baud	OFF	OFF	ON
2400 baud	OFF	ON	OFF
4800 baud	OFF	ON	ON
9600 baud	ON	OFF	OFF
19200 baud	ON	OFF	ON
38400 baud	ON	ON	OFF
57600 baud	ON	ON	ON

ModbusRTU Parity & Stop Bits

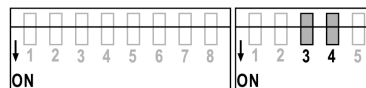

Parity	DIP3	DIP4
(reserved)	OFF	OFF
No parity, 2 stop bits	OFF	ON
Even parity, 1 stop bit	ON	OFF
Odd parity, 1 stop bit	ON	ON

ModbusRTU Physical Interface



Interface Type	DIP5
RS232	ON
RS485	OFF

migan MPB ModbusRTU

Large Display Numeric LED with Modbus RTU Interface

Important note:

To change the setting of the DIP-switches obey the following order:

- Disconnect the power supply.
- Open the housing.
- Set the dip switches as desired.
- Close the housing.
- Reconnect the power supply.

While the housing is open power may only be applied by qualified personnel and nothing has to be touched inside the housing at this time! Otherwise electrical shock and danger to life may happen! Please be careful!

3.4 Device Start-Up

Internal memory and function tests are performed at the large format display during power-up:

- Segment test

migan MPB ModbusRTU

Large Display Numeric LED with Modbus RTU Interface

4 ModbusRTU Interface

The display represents a ModbusRTU-Slave and is controlled by a ModbusRTU-Master (f.e. a PLC).

To change the display contents, the ModbusRTU-Master has to write to some registers. Therefore the commands “Force Multiple Registers” (function code 16_d=10_H) or “Read/Write Registers” (function code 23_d=17_H) can be used.

Here, we assume that “registers” are counted beginning at “0”. If your PLC starts counting at “1”, you may have to increase the register address by 1!

ModbusRTU output data must be entered as follows:

Register (Output)	HMS memory address	Contents	Description
0400 _H HIGH	200 _H	00 _H	Control register HIGH: static 0 (don't change)!
LOW	201 _H	00 _H	Control register LOW: static 0 (don't change)!
0401 _H HIGH	202 _H	XX _H	Trigger byte: The transmission of the frame is executed with an increasing by one
LOW	203 _H	XX _H	Length byte: Number of following bytes (ADR...CHK)
0402 _H HIGH	204 _H	01 _H	ADR
LOW	205 _H	XX _H	LEN
0403 _H HIGH	206 _H	XX _H	O1
LOW	207 _H	XX _H	O2
0404 _H HIGH	208 _H	XX _H	O3
LOW	209 _H	XX _H	O4
0405 _H HIGH	20A _H	XX _H	D1
:	:	:	:
:	:	XX _H	Dn
:	:	55 _H	CHK

control frame

The length byte and the **control frame** (see next chapter) must be entered first.

Then, the trigger byte must be increased by one.
Thereby, the entered frame is transmitted to the MIGAN.

migan MPB ModbusRTU

Large Display Numeric LED with Modbus RTU Interface

The response appears in the **Modbus RTU input data**:

Register (Input)	HMS memory address	Contents	Description
0000 _H HIGH	000 _H	9F _H	Status register HIGH: without meaning!
LOW	001 _H	00 _H	Status register LOW: without meaning!
0001 _H HIGH	002 _H	XX _H	Trigger byte: Is increased by 1 value after the reception of every response frame
LOW	003 _H	04 _H	Length byte: Number of following bytes
0002 _H HIGH	004 _H	01 _H	ADR
LOW	005 _H	02 _H	LEN
0003 _H HIGH	006 _H	XX _H	I1
LOW	007 _H	55 _H	CHK

} response frame

migan MPB ModbusRTU

Large Display Numeric LED with Modbus RTU Interface

4.1 Control Frame

ADR	LEN	O1
Device address	Number of following bytes (from O1 to CHK)	Options
01 _H	XX _H	<p>Bit 7: report software version</p> <p>Bit 6: 0 = Statically display the last received data (standard) 1 = Display "----", if no new data is received within 5 s.</p> <p>Bits 5...4: <u>Brightness</u> 00 = 100% 01 = 80% 10 = 60% 11 = 40%</p> <p>Bit 3 = Digital output 4 Bit 2 = Digital output 3 Bit 1 = Digital output 2 Bit 0 = Digital output 1</p> <p>Output will be set, if corresponding bit = 1</p>

Continued on next page.

migan MPB ModbusRTU

Large Display Numeric LED with Modbus RTU Interface

O2	
Output format	
Bits 7...4:	<u>Physical number of digits (bit coded)</u> 0001...1111 = 1...15 digits 0000 = ASCII representation with up to 40 digits
Bit 3:	<u>Mode</u> 0 = LSB first 1 = MSB first
Bits 2...0:	<u>Data type*</u> <u>max. number of digits</u>
	000 = unsigned CHAR (0...255) 3
	001 = unsigned INT (0...65535) 5
	010 = unsigned LONG (0...4294967296) 10
	011 = signed CHAR (-128...127) 4
	100 = signed INT (-32768...32767) 6
	101 = signed LONG (-2147483648... 2147483647) 11
	110 = ASCII representation 40
	111 = reserved
	* at value representation: right-aligned display at ASCII representation: left-aligned display

O3	O4	D1...Dn	CHK
Decimal points	Decimal points, blinking	Data bytes (value- or ASCII representation)	Checksum
Bit 7 = digit 1 Bit 6 = digit 2 Bit 5 = digit 3 Bit 4 = digit 4 Bit 3 = digit 5 Bit 2 = digit 6 Bit 1 = digit 7 Bit 0 = digit 8	Bit 7 = digit 9 Bit 6 = digit 10 Bit 5 = digit 11 Bit 4 = digit 12 Bit 3 = digit 13 Bit 2 = digit 14 Bit 1 = digit 15 Bit 0 = Display blinks	<u>Value representation:</u> CHAR value: 1 byte INT value: 2 bytes LONG value: 4 bytes <u>ASCII representation (max. 80 bytes):</u> 1 byte per character, max. 40 digits, Bit 7 = 1: digit blinks The decimal point has character code 2CH or 2EH and is always set at the previous digit.	55H

A point is set, if corresponding bit = 1

Controlling devices with multiple display areas (e.g. 2 lines):

The partition from O2...Dn is used repeatedly according to the number of display areas (see example 3).

Please attend to the maximum total frame length of 150 bytes.

migan MPB ModbusRTU

Large Display Numeric LED with Modbus RTU Interface

4.2 Response Frame

Digital inputs are optionally available (depending on display type).

ADR	LEN	I1	CHK
Device address	Length	Digital Input	Checksum
01 _H	02 _H	Bit 7 = Event digital input 4 Bit 6 = Event digital input 3 Bit 5 = Event digital input 2 Bit 4 = Event digital input 1 Bit 3 = Status digital input 4 Bit 2 = Status digital input 3 Bit 1 = Status digital input 2 Bit 0 = Status digital input 1	55 _H

Event of a digital input = 1, if it has been set at least once since the last query (f.e. with a button). The event is deleted after every query.

Status of a digital input = 1, if it's set at the moment.

migan MPB ModbusRTU

Large Display Numeric LED with Modbus RTU Interface

4.3 Controlling Example

- Display with 4 digits
- Show value “1234”
- Mode: LSB first
- Data type: unsigned INT

STEP1: Enter **ModbusRTU Output Data:**

Register (Output)	HMS memory address	Contents	Description
0400 _H HIGH	200 _H	00 _H	Control register HIGH: static 0(don't change)!
LOW	201 _H	00 _H	Control register LOW: static 0(don't change)!
0401 _H HIGH	202 _H	00 _H ↓ 01 _H	Trigger byte: The transmission of the frame is executed with an increasing by one (after the entries in HMS memory address 203 _H ... 20C _H have been done!)
LOW	203 _H	09 _H	Length byte
0402 _H HIGH	204 _H	01 _H	ADR
LOW	205 _H	07 _H	LEN
0403 _H HIGH	206 _H	00 _H	O1
LOW	207 _H	41 _H	O2 (4 digits, unsigned INT)
0404 _H HIGH	208 _H	00 _H	O3
LOW	209 _H	00 _H	O4
0405 _H HIGH	20A _H	D2 _H	D1 (LOW byte of INT value “1234”)
LOW	20B _H	04 _H	D2 (HIGH byte of INT value “1234”)
0406 _H HIGH	20C _H	55 _H	CHK

STEP2: The response appears in the **Modbus RTU input data:**

Register (Input)	HMS memory address	Contents	Description
0000 _H HIGH	000 _H	9F _H	Status register HIGH: without meaning!
LOW	001 _H	00 _H	Status register LOW: without meaning!
0001 _H HIGH	002 _H	00 _H ↓ 01 _H	Trigger byte: Is increased by 1 value after the reception of every response frame
LOW	003 _H	04 _H	Length byte
0002 _H HIGH	004 _H	01 _H	ADR
LOW	005 _H	02 _H	LEN
0003 _H HIGH	006 _H	00 _H	I1
LOW	007 _H	55 _H	CHK

migan MPB ModbusRTU

Large Display Numeric LED with Modbus RTU Interface

5 Appendix

5.1 Displayable Characters

The data bytes are ASCII coded.

Lower ⤴	Higher ⤵	0	1	2	3	4	5	6	7
0				"Blank"	0		P		P
1					1	A	9	A	9
2					2	6	7	6	7
3					3	c	5	c	5
4					4	d	E	d	E
5					5	E	L	E	L
6					6	F		F	
7					7	G		G	
8			C		8	H		H	
9			J		9	I	4	I	4
A						J		J	
B									
C						L		L	
D			-						
E						n		n	
F						o	-	o	

migan MPB ModbusRTU

Large Display Numeric LED with Modbus RTU Interface

5.2 Maintenance and Care

Please observe the following instructions:

- Make sure that the housing can be opened for adjustment and maintenance even after the display has been installed. Allow for adequate clearance at the back, front and top of the display unit in order to allow for sufficient ventilation (if vent slots are included).
- Display quality is impaired by direct illumination with bright light sources and/or direct sunlight.
- The display must be switched off before cleaning.
- Protect the display from excessive humidity, extreme vibration, direct sunlight and extreme temperatures. Non-observance may lead to malfunctioning or destruction of the device. Under certain circumstances electrical shock, fire and explosion may occur as well. Information concerning allowable ambient conditions, including recommended temperature ranges, can be found in the chapter entitled "Technical Information".
- The display may not be placed into service if the device and/or the power cable are known to be damaged.
- Do not attempt to repair the device yourself. The guarantee is rendered null and void if the device is tampered with by unauthorised persons.

migan MPB ModbusRTU

Large Display Numeric LED with Modbus RTU Interface

5.3 Declaration of Conformity

EU-Konformitätserklärung

EU Declaration of Conformity

Produktbezeichnung: migan
Product name:

Typenreihe: migan ModbusRTU
Type code:

Hersteller: microSYST Systemelectronic GmbH
Manufacturer: Am Gewerbepark 11
 92670 Windischeschenbach

Das bezeichnete Produkt stimmt mit der folgenden Europäischen Richtlinie überein: <i>We herewith confirm that the above mentioned product meets the requirements of the following standard:</i>		Die Übereinstimmung des bezeichneten Produktes mit den Vorschriften der angewandten Richtlinie(n) wird nachgewiesen durch die Einhaltung folgender Normen / Vorschriften: <i>The conformity of the product described above with the provisions of the applied Directive(s) is demonstrated by compliance with the following standards / regulations:</i>
Richtlinien / Directives		Europäische Norm / Standard
EMV Richtlinie <i>EMC Directive</i>	2014/30/EU	EN61000-6-2:2005
		EN61000-6-4:2007 +A1:2011
Niederspannungs-Richtlinie <i>Low Voltage Directive</i>	2014/35/EU	EN IEC 62368-1:2021-05
RoHS Richtlinie <i>RoHS Directive</i>	2011/65/EU	EN50581:2012

Windischeschenbach, 06.05.2021



Manuel Raß

Geschäftsführer / General Manager

migan MPB ModbusRTU

Large Display Numeric LED with Modbus RTU Interface

5.4 Warranty / Liability

For the product, liability is assumed for defects, which existed at the delivery date according to our General Terms and Conditions.

Technically changes as well as errors are accepted. A claim for delivery of a new product does not exist. The buyer has to check the received product immediately and indicate evident defects at the latest 24 hours after detection. Non-observance of notification requirements is equated with acceptance of the defect. Not immediately visible defects have to be indicated immediately after their perception too.

Generally, defects and their symptoms must be described as accurately as possible in order to allow for reproducibility and elimination. The buyer must provide for access to the relevant device and all required and/or useful information at no charge and must make all of the required data and machine time available free of charge.

The guarantee does not cover defects, which result from non-observance of the prescribed conditions of use, or from improper handling.

If the device has been placed at the disposal of the buyer for test purposes and has been purchased subsequent to such testing, both parties agree that the product is to be considered “used” and that it has been purchased “as is”. No guarantee claims may be made in such cases.

The General Terms and Conditions of microSYST Systemelectronic GmbH in current version apply as well.

migan MPB ModbusRTU

Large Display Numeric LED with Modbus RTU Interface

5.5 Versions Overview

Version	Date	Remark, Description
1.00	19.11.13	Document created (based on X-M32-BSXXMX-001)
1.10	20.11.13	Logo
1.20	22.01.14	migan 2 -> migan
1.30	27.04.16	Declaration of conformity
2.00	17.11.16	migan2 → migan MPB
2.10	13.11.17	Change of address and title MPB
2.20	06.05.21	Declaration of conformity

Certified per **DIN EN ISO 9001**.