

# migra ModbusRTU

Large Format, Graphics Compatible Display with ModbusRTU Interface

## User's Manual



# migra Modbus RTU

Large Format, Graphics Compatible Display with ModbusRTU Interface

## Index

<b>1</b>	<b>GENERAL</b>	<b>3</b>
<b>2</b>	<b>SYSTEM OVERVIEW</b>	<b>3</b>
<b>3</b>	<b>MODBUSRTU INTERFACE</b>	<b>4</b>
3.1	Display Control Via ModbusRTU	5
3.2	Example	7
3.3	Connector Pin Assignments	8
3.3.1	External Connections	8
3.3.2	Internal LEDs and Switches	10
<b>4</b>	<b>DECLARATION OF CONFORMITY</b>	<b>13</b>
<b>5</b>	<b>VERSIONS OVERVIEW</b>	<b>14</b>

# migra Modbus RTU

Large Format, Graphics Compatible Display with ModbusRTU Interface

## 1 General

This display is based on the „migra Serial“, which is expanded by a Modbus-RTU interface.

The interface is used for the connection to a ModbusRTU controller (PLC) at one side and the data exchange (RS485 frames) to the display at the other side.

The frames for the display correspond to those of the „serial MIGRA“ and are described in the **User’s Manual „migra Serial“**.

## 2 System Overview

The display is controlled with a ModbusRTU interface.

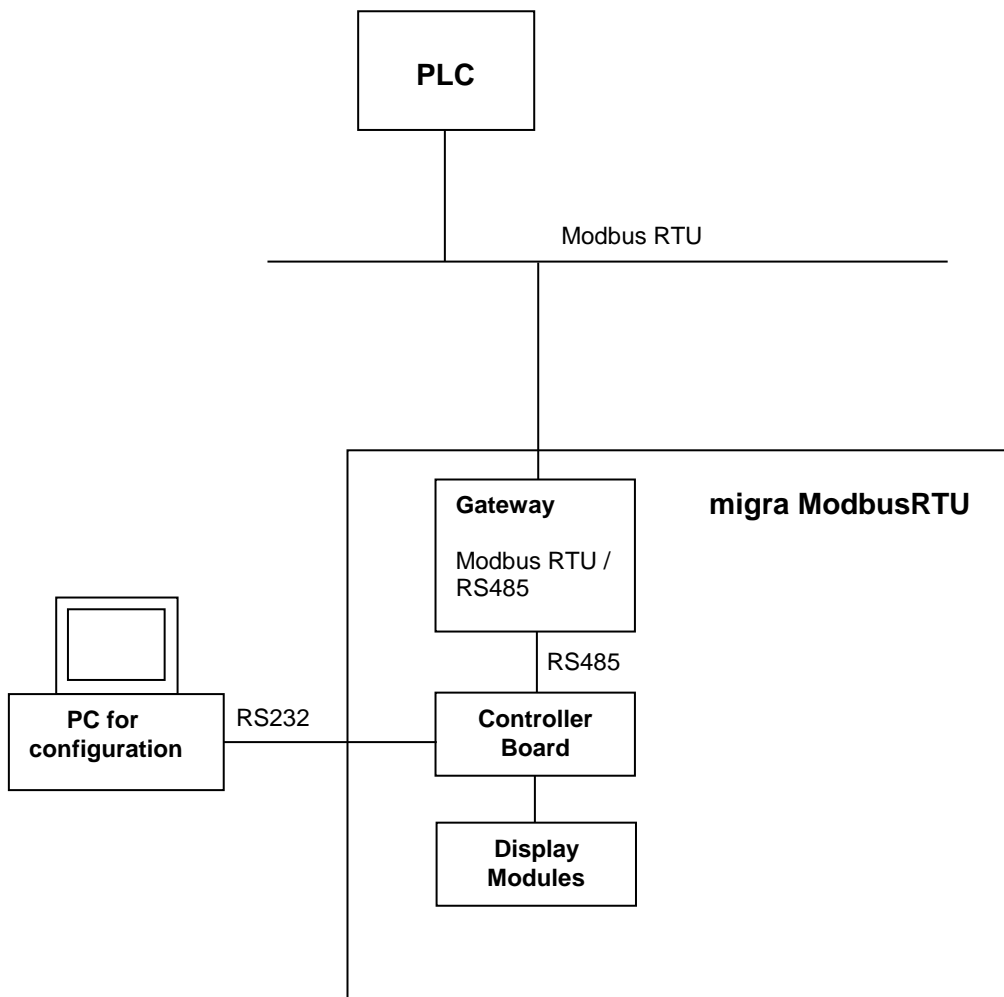

# migra Modbus RTU

Large Format, Graphics Compatible Display with ModbusRTU Interface

## 3 ModbusRTU Interface

The internal interface is the „ Modbus RTU Serial Gateway“ of the company HMS (AB7010). You can find the documentation at the home page of HMS ([www.anybus.com](http://www.anybus.com)).

# migra Modbus RTU

Large Format, Graphics Compatible Display with ModbusRTU Interface

## 3.1 Display Control Via ModbusRTU

The display represents a ModbusRTU-Slave and is controlled by a ModbusRTU-Master (f.e. a PLC).

To change the display contents, the ModbusRTU-Master has to write to some Registers. Therefore the commands "Force Multiple Registers" (function code  $16_{d=10_{H}}$ ) or "Read/Write Registers" (function code  $23_{d=17_{H}}$ ) can be used.

Here we assume that "Registers" are counted beginning at "0". If your PLC starts counting at "1" you may have to increase the register-address by 1!

The frames, which are described in the user's manual „migra Serial“ („02 81 80 8X DATA-Unit 03“), must be entered in the **ModbusRTU output data** as follows:

Register (Output)	HMS memory address	Contents	Description
0400 <sub>H</sub> HIGH	200 <sub>H</sub>	0	Control register HIGH: static 0(don't change)!
LOW	201 <sub>H</sub>	0	Control register LOW: static 0(don't change)!
0401 <sub>H</sub> HIGH	202 <sub>H</sub>	XX	Trigger byte: The transmission of the frame is executed with an increasing by one
LOW	203 <sub>H</sub>	6... n+5	Length byte: frame length
0402 <sub>H</sub> HIGH	204 <sub>H</sub>	02 <sub>H</sub>	MIGRA frame „STX“ (static)
LOW	205 <sub>H</sub>	81 <sub>H</sub>	MIGRA frame „DA“ (destination address)
0403 <sub>H</sub> HIGH	206 <sub>H</sub>	80 <sub>H</sub>	MIGRA frame „SA“ (static)
LOW	207 <sub>H</sub>	80 <sub>H</sub> or 81 <sub>H</sub>	MIGRA frame „FC“: 0x80 = „without response“, 0x81 = „with response“
0404 <sub>H</sub> HIGH	208 <sub>H</sub>	XX	MIGRA frame „Data unit, 1 <sup>st</sup> Byte“
LOW	209 <sub>H</sub>	XX	MIGRA frame „Data unit, 2 <sup>nd</sup> Byte“
0405 <sub>H</sub> HIGH	20A <sub>H</sub>	XX	MIGRA frame „Data unit, 3 <sup>rd</sup> Byte“
LOW	...	XX	...
... HIGH	208 <sub>H</sub> + (n-1)	XX	MIGRA frame „Data unit, n <sup>th</sup> Byte“
... LOW	208 <sub>H</sub> + n	03 <sub>H</sub>	MIGRA frame „ETX“ (static)

The length byte and the MIGRA frame must be entered first. Then, the trigger byte must be increased by one.

Thereby, the entered frame is transmitted to the MIGRA.

If the controlling happens without response frame („FC“ = 80<sub>H</sub>), the respectively next frame must be sent approx. 100 to 200 ms soonest!

If you use the response („FC“ = 81<sub>H</sub>), the respectively next frame may be sent immediately after receiving the response!

# migra Modbus RTU

Large Format, Graphics Compatible Display with ModbusRTU Interface

A possible response appears in the **Modbus RTU input data**:

Register (Input)	HMS memory address	Contents	Description
0000 <sub>H</sub> HIGH	000 <sub>H</sub>	0x9F	Status register HIGH: without meaning!
LOW	001 <sub>H</sub>	0	Status register LOW: without meaning!
0001 <sub>H</sub> HIGH	002 <sub>H</sub>	XX	Trigger byte: Is increased by 1 value after the reception of every response frame
LOW	003 <sub>H</sub>	n+5	Length byte: response length
0002 <sub>H</sub> HIGH	004 <sub>H</sub>	02 <sub>H</sub>	MIGRA response „STX“ (static)
LOW	005 <sub>H</sub>	80 <sub>H</sub>	MIGRA response „DA“ (static)
0003 <sub>H</sub> HIGH	006 <sub>H</sub>	81 <sub>H</sub>	MIGRA response „SA“ (source address)
LOW	007 <sub>H</sub>	80 <sub>H</sub>	MIGRA response „FC“ (static)
0004 <sub>H</sub> HIGH	008 <sub>H</sub>	XX	MIGRA response „Data unit, 1 <sup>st</sup> Byte“
LOW	009 <sub>H</sub>	XX	MIGRA response „Data unit, 2 <sup>nd</sup> Byte“
0005 <sub>H</sub> HIGH	00A <sub>H</sub>	XX	MIGRA response „Data unit, 3 <sup>rd</sup> Byte“
LOW	...	XX	...
... HIGH	008 <sub>H</sub> + (n-1)	XX	MIGRA response „Data unit, n <sup>th</sup> Byte“
... LOW	08 <sub>H</sub> + n	03 <sub>H</sub>	MIGRA response „ETX“ (static)

The “Data unit” usually consists only of one byte (30<sub>H</sub>).

**Note:**

In most cases, you do not need the response frame!

The necessary frame intervals, which depend on the effort for the evaluation, can also be found by trying (200 ms is OK for most applications).

# migra Modbus RTU

Large Format, Graphics Compatible Display with ModbusRTU Interface

## 3.2 Example

The online text „microSYST“ shall be shown at the display (without response):

### ModbusRTU Output Data:

Register (Output)	HMS memory address	Contents	Description
0400 <sub>H</sub> HIGH	200 <sub>H</sub>	0	Control register HIGH: static 0(don't change)!
LOW	201 <sub>H</sub>	0	Control register LOW: static 0(don't change)!
0401 <sub>H</sub> HIGH	202 <sub>H</sub>	x ↓ x+1	Trigger byte: The transmission of the frame is executed with an increasing by one ( <b>after</b> the entries in HMS memory address 203 <sub>H</sub> ...211 <sub>H</sub> have been done!)
LOW	203 <sub>H</sub>	14	Length byte: frame length
0402 <sub>H</sub> HIGH	204 <sub>H</sub>	02 <sub>H</sub>	MIGRA frame „STX“ (static)
LOW	205 <sub>H</sub>	81 <sub>H</sub>	MIGRA frame „DA“ (destination address)
0403 <sub>H</sub> HIGH	206 <sub>H</sub>	80 <sub>H</sub>	MIGRA frame „SA“ (static)
LOW	207 <sub>H</sub>	80 <sub>H</sub>	MIGRA frame „FC“ (without response)
0404 <sub>H</sub> HIGH	208 <sub>H</sub>	6D <sub>H</sub>	= 'm'
LOW	209 <sub>H</sub>	69 <sub>H</sub>	= 'i'
0405 <sub>H</sub> HIGH	20A <sub>H</sub>	63 <sub>H</sub>	= 'c'
LOW	20B <sub>H</sub>	72 <sub>H</sub>	= 'r'
0406 <sub>H</sub> HIGH	20C <sub>H</sub>	6F <sub>H</sub>	= 'o'
LOW	20D <sub>H</sub>	53 <sub>H</sub>	= 'S'
0407 <sub>H</sub> HIGH	20E <sub>H</sub>	59 <sub>H</sub>	= 'Y'
LOW	20F <sub>H</sub>	53 <sub>H</sub>	= 'S'
0408 <sub>H</sub> HIGH	210 <sub>H</sub>	54 <sub>H</sub>	= 'T'
LOW	211 <sub>H</sub>	03 <sub>H</sub>	MIGRA frame „ETX“ (static)

# migra Modbus RTU

Large Format, Graphics Compatible Display with ModbusRTU Interface

## 3.3 Connector Pin Assignments

### 3.3.1 External Connections

#### 9pol. Sub-D Female Connector “ModbusRTU”

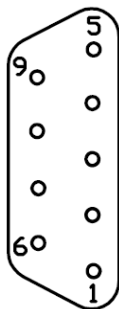

Pin	Assignment
1	
2	RS-232 TxD
3	RS-232 RxD
4	
5	GND Bus
6	+5V Bus Out
7	RS-485 D0 (Rx/Tx-)
8	RS-485 D1 (Rx/Tx+)
9	

**Remark:** Depending on DIP5 of the ModbusRTU-interface (see below) **either** the RS232-pins **or** the RS485-pins may be used. The unused pins have to be left open. Do **not** use a standard RS232-cable where **all** pins are connected. Otherwise the ModbusRTU-interface may be destroyed!!!

#### 9pol. Sub-D Male Connector “RS232 migra”

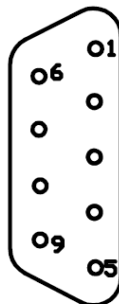

Pin	Assignment
1	
2	RxD
3	TxD
4	
5	GND
6	
7	
8	
9	

This connector serves for the configuration of the migra display.



# migra Modbus RTU

Large Format, Graphics Compatible Display with ModbusRTU Interface

## Connector “Modbus Config”

Remark: This connector should not be used by the customer! The configuration is already done by microSYST and must not be changed! Otherwise the correct function of the display can not be guaranteed!

## 7pol. Mains Plug (230 VAC)

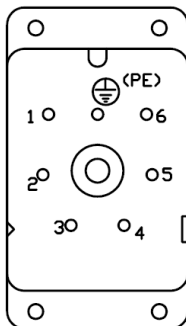

Pin	Assignment
1	L1
2	N
⊕ (PE)	PE

# migra Modbus RTU

Large Format, Graphics Compatible Display with ModbusRTU Interface

## 3.3.2 Internal LEDs and Switches

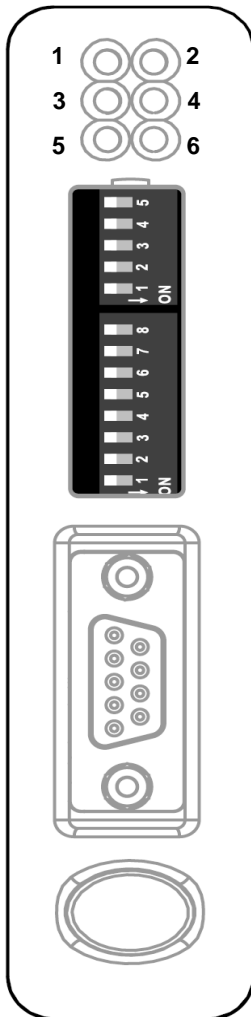

LED	State	Description
1 - Bus Error	Off	Normal operation
	Red	Bus error; CRC mismatch >10%
2 - Bus Ready	Off	Not powered
	Green	Normal operation (bus ready)
3 - Processing	Red	Bus is off line (bus not ready)
	Off	Currently not processing query
4 - HW Settings	Green, flashing	Currently processing query
	Off	Normal operation
5 - Subnet Status	Red	Not configured
	Off	Power off
	Green, flashing	Initializing and not running
	Green	Running
6 - Device Status	Red	Stopped or subnet error, or timeout
	Off	Power off
	Alternating Red/Green	Invalid or missing configuration
	Green	Initializing
	Green, flashing	Configuration OK

# migra Modbus RTU

Large Format, Graphics Compatible Display with ModbusRTU Interface

## ModbusRTU Node Address

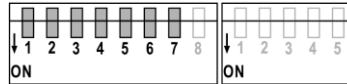

Node Address	DIP1	DIP2	DIP3	DIP4	DIP5	DIP6	DIP7
(reserved)	OFF	OFF	OFF	OFF	OFF	OFF	OFF
* 1	OFF	OFF	OFF	OFF	OFF	OFF	ON
2	OFF	OFF	OFF	OFF	OFF	ON	OFF
...	...	...	...	...	...	...	...
126	ON	ON	ON	ON	ON	ON	OFF
127	ON	ON	ON	ON	ON	ON	ON

\* = Factory-Setting

## ModbusRTU Baudrate

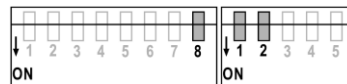

Baudrate	DIP8	DIP1	DIP2
(reserved)	OFF	OFF	OFF
1200 baud	OFF	OFF	ON
2400 baud	OFF	ON	OFF
4800 baud	OFF	ON	ON
9600 baud	ON	OFF	OFF
* 19200 baud	ON	OFF	ON
38400 baud	ON	ON	OFF
57600 baud	ON	ON	ON

\* = Factory-Setting

## ModbusRTU Parity & Stop Bits

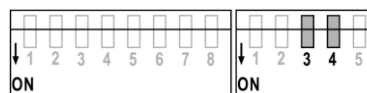

Parity	DIP3	DIP4
(reserved)	OFF	OFF
* No parity, 2 stop bits	OFF	ON
Even parity, 1 stop bit	ON	OFF
Odd parity, 1 stop bit	ON	ON

\* = Factory-Setting

## ModbusRTU Physical Interface

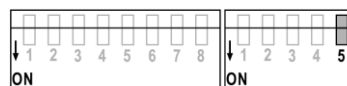

Interface Type	DIP5
RS232	ON
* RS485	OFF

\* = Factory-Setting

# migra Modbus RTU

Large Format, Graphics Compatible Display with ModbusRTU Interface

## **Important note:**

To change the setting of the DIP-switches obey the following order:

- disconnect the power supply
- open the housing
- open the dip switch protection cap (carefully - using a little screw driver)
- set the dip switches as desired
- close the dip switch protection cap
- close the housing
- reconnect the power supply

**While the housing is open power may only be applied by qualified personnel and nothing has to be touched inside the housing at this time! Otherwise electrical shock and danger to life may happen! Please be careful!**

# migra Modbus RTU

Large Format, Graphics Compatible Display with ModbusRTU Interface

## 4 Declaration of Conformity

### EU-Konformitätserklärung EU Declaration of Conformity

**Produktbezeichnung:** migra  
*Product name:*

**Typenreihe:** migra Modbus RTU  
*Type code:*

**Hersteller:** microSYST Systemelectronic GmbH  
*Manufacturer:* Am Gewerbepark 11  
92670 Windischeschenbach

<b>Das bezeichnete Produkt stimmt mit der folgenden Europäischen Richtlinie überein:</b> <i>We herewith confirm that the above mentioned product meets the requirements of the following standard:</i>		<b>Die Übereinstimmung des bezeichneten Produktes mit den Vorschriften der angewandten Richtlinie(n) wird nachgewiesen durch die Einhaltung folgender Normen / Vorschriften:</b> <i>The conformity of the product described above with the provisions of the applied Directive(s) is demonstrated by compliance with the following standards / regulations:</i>
<b>Richtlinien / Directives</b>		<b>Europäische Norm / Standard</b>
<b>EMV Richtlinie</b> <i>EMC Directive</i>	<b>2014/30/EU</b>	EN61000-6-2:2005
		EN61000-6-4:2007 +A1:2011
<b>Niederspannungs-Richtlinie</b> <i>Low Voltage Directive</i>	<b>2014/35/EU</b>	EN60950-1:2006 +A11:2009 +A1:2010 +A12:2011 +A2:2013
<b>RoHS Richtlinie</b> <i>RoHS Directive</i>	<b>2011/65/EU</b>	EN50581:2012

Windischeschenbach, 16.11.2017



Manuel Raß

**Geschäftsführer / General Manager**

# migra Modbus RTU

Large Format, Graphics Compatible Display with ModbusRTU Interface

## 5 Versions Overview

Version	Date	Remark, Description
1.00	29.06.08	Kreuzer, Nickl: Document created
1.10	16.08.10	SC/MC 5/3 -> SC/MC
1.20	12.03.15	SC/MC removed
1.30	03.05.16	Declaration of conformity
1.40	16.11.17	Change of address

Certified per **DIN EN ISO 9001**.